



FRONX





SHAPE YOUR New

The all-new Suzuki Fronx is unlike any other SUV on the market. From its stylish coupé design and striking design elements of other Suzuki models, to innovative technology that ensures exceptional safety and driving comfort.

The Suzuki Fronx represents the “Next Frontier” of SUVs and evokes a daring free spirit. Designed for those who are fearlessly shaping their own path in life, with attitude and style.

TURN HEADS WHEREVER YOU GO

The proudly-different, all-new Suzuki Fronx boasts dynamic design with arresting styling. It strikes a commanding presence on the road, thanks to its bold front and rear fascia, and muscular shoulder lines.

- Geometric Precision Cut Alloy Wheels
- Grille & Striking Front Fascia
- Aerodynamic Design





WHERE POWER MEETS INNOVATION

The Suzuki Fronx comes with a powerful 1.5-litre K15B petrol engine, giving you impressive power output of 77kW and torque of 138 Nm. The engine is paired to a five-speed manual or a four-speed automatic transmission, making this the perfect crossover SUV for city driving and outdoor adventuring. This performance is matched with good fuel efficiency. The Fronx Manual Transmission offers 5.5ℓ/100km and the Fronx Automatic Transmission 5.7ℓ/100km.

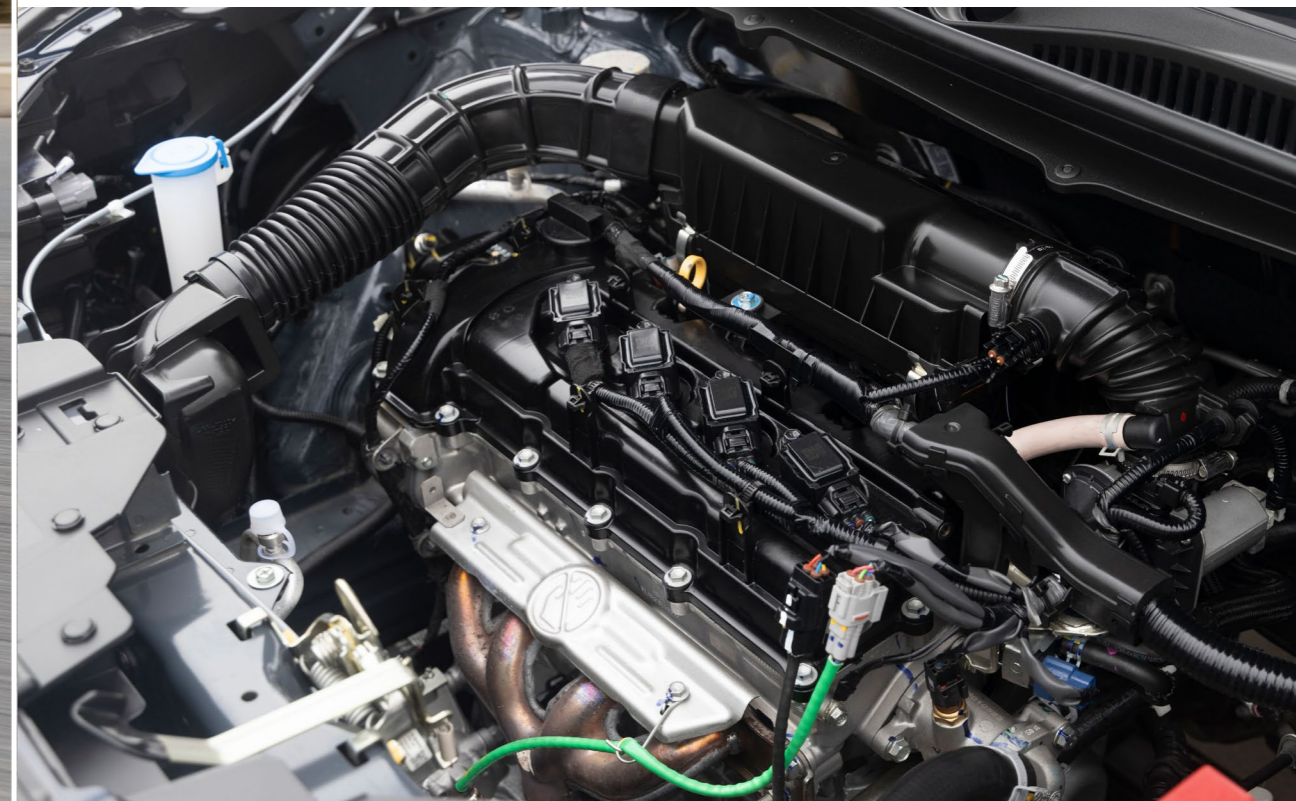

SAFETY FIRST

Feel safe, knowing that the all-new Fronx comes with a host of safety features designed to protect the driver, passengers and pedestrians.

HEARTECT PLATFORM

The Fronx rests on Suzuki's HEARTECT platform, which delivers enhanced fundamental vehicle performance as it is lighter and highly rigid. Its smooth, curving form effectively disperses impact energy in the case of a collision and its lighter weight ensures fuel efficiency.

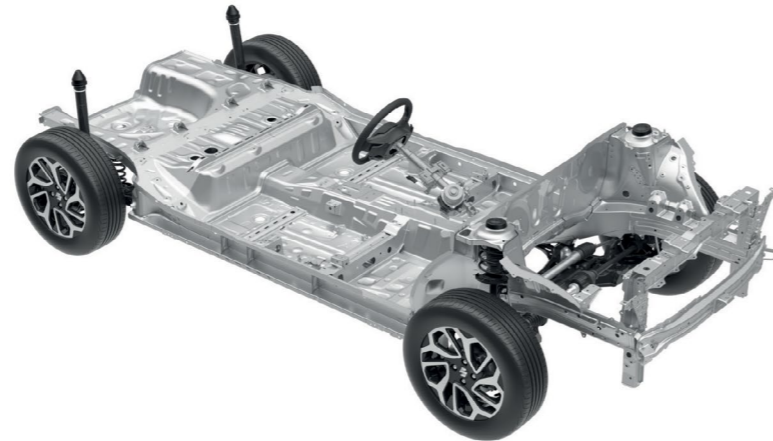

AIRBAGS

The Fronx comes standard with dual front airbags to protect the driver and co-passenger. The Fronx GLX boasts additional dual side and curtain airbags.



All seats have three-point seat belts, plus the front seats have pretensioners and force limiters, ensuring everyone inside is as safe as possible.

ELECTRONIC STABILITY PROGRAM (ESP®)

Stay in control on the road with ESP®, which automatically takes control of the engine torque and brakes to help you maintain directional control when the road is slippery or you have to turn the wheel sharply.

ESP is a registered trademark of Mercedes-Benz Group AG. The ESP is designed to help keep the new Fronx under control. However, its effectiveness depends on driving conditions and the state of the road surface. If the tyres exceed their grip limit and the wheels start to spin or skid, it may not be fully effective.

HILL HOLD ASSIST

This is an important function that prevents the vehicle from rolling backward when the driver releases the brakes during standing starts on hills or slopes.



- With hill hold control
- Without hill hold control

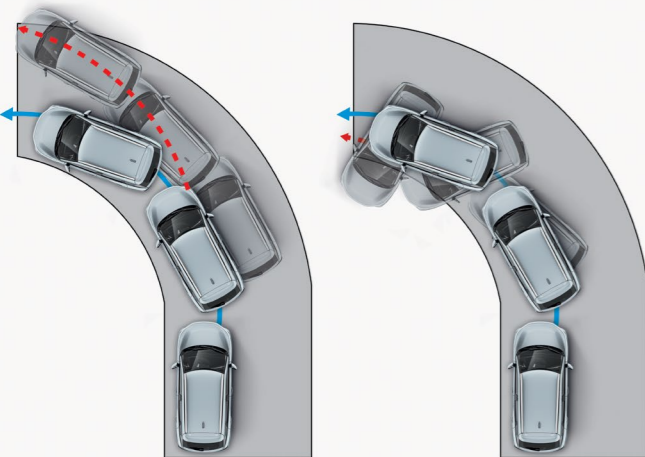

WHERE LUXURY & SOPHISTICATION MEET

You'll feel the difference from the moment you get inside. The dual-tone dashboard with special forged metal finish and accents adds a quality touch to the interior and accentuates the steering wheel and infotainment system.

Every detail has been considered to make your driving experience effortless - from the driver armrest, rear AC vents to the fast-charging connectivity.



- **Cabin Space** - Luxuriate with plenty of room for five adults.
- **Luggage Capacity** - Enjoy a roomy luggage capacity of 304 litres while the low opening height makes loading and unloading a breeze.



TOUCH INNOVATION

The Suzuki Fronx is primed with the latest technology to enhance your driving experience. The 9" (GLX) and 7" (GL) infotainment system takes centre stage and offers a premium display for maximum convenience.

Another impressive feature is the 360° View camera* and Head-Up Display* designed to keep you safely in control of your environment.

*GLX Model



- Cruise control and steering-mounted controls ensure an added touch of comfort.
- Supports both Apple CarPlay® and Android Auto™ smartphone connectivity.
- The home screen and quick-access hub screen are customisable by setting frequently used functions on the screens.

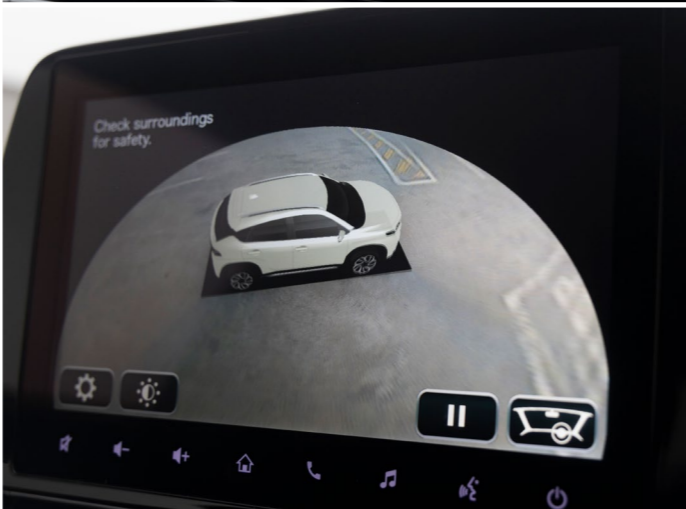

READY TO SHAPE YOUR NEW?

Sharp details, intuitive tech, and premium finishes, puts the Suzuki Fronx in a league of its own and opens up a world of possibilities for you to explore.



MAJOR SPECIFICATIONS

Steering	RHD
Number of doors	5-door
Engine	Petrol
	1.5ℓ
Drive system	2WD

DIMENSIONS

Overall length (mm)	3 995	
Overall width (mm)	1 765	
Overall height (mm)	1 550	
Wheelbase (mm)	2 520	
Tread	Front (mm)	1 520
	Rear (mm)	1 530
Minimum turning radius (m)	4,8	
Minimum ground clearance (mm)	170	

CAPACITIES

Seating capacity	Persons	5	
Fuel tank capacity	ℓ	37	
Luggage capacity *1	Max volume	ℓ	1 009
	Rear seatback folded (VDA method) - with 195/60 R16 spare tyre	ℓ	605
	Rear seatback folded (VDA method)	ℓ	304

ENGINE

Type	K15B	
Number of cylinders	4	
Number of valves	16	
Piston displacement	cm3	1 462
Bore x stroke	mm	74 x 85
Compression ratio	10.5	
Maximum output	kW/rpm	77 / 6 000
Maximum torque	N-m/rpm	138 / 4 400
Fuel distribution	Multi-point injection	

TRANSMISSION

Type	K15B		
		5MT	4AT
Gear ratio	1 st	3.545	2.875
	2 nd	1.905	1.568
	3 rd	1.233	1.000
	4 th	0.886	0.697
	5 th	0.690	-
	Reverse	3.250	2.300
Final gear ratio		4.412	4.145

CHASSIS

Steering	Rack & Pinion	
Brakes	Front	Ventilated disc
	Rear	Drum, leading & trailing
Suspension	Front	MacPherson strut
	Rear	Torsion beam
Tyres	195/60 R16	

WEIGHTS

Type	K15B		
		5MT	4AT
Kerb weight (min./with full option)	kg	1.005 / 1.010	1.010 / 1.015
Gross vehicle weight	kg	1 480	1 480

PERFORMANCE

Maximum speed (km/h)	175	170
----------------------	-----	-----

*1 Manufacture data

MAJOR EQUIPMENT

Type	K15B	
Drive system	2WD	
GRADE	GL	GLX
TRANSMISSION	5MT/4AT	5MT/4AT

CHASSIS

Tyres and wheels	195/60 R16 + alloy wheels (Painted)	⊕	-
	195/60 R16 + alloy wheels (Polished)	-	⊕
Spare tyre and wheel	195/60 R16 + steel wheel	⊕	⊕

EXTERIOR

Front grille	Chrome + material	⊕	-
	Chrome + paint	-	⊕
Roof rail garnish	Black	⊕	⊕
	Silver	-	⊕
Outside door handles	Body coloured	⊕	⊕
Outside mirror	Body coloured (if monotone)	⊕	⊕
	Black (if 2-tone)	⊕	⊕
Skid plate garnish	Front	⊕	⊕
	Rear	⊕	⊕
Wheel arch extensions		⊕	⊕
Door beltline garnish	Chrome	-	⊕
Tailgate opener	Electromagnetic	⊕	⊕

VISIBILITY

Headlamps	LED multi-reflector	⊕	⊕
	Follow me home system	⊕	⊕
Headlamp leveling device	Manual	⊕	⊕
Automatic lamps		⊕	⊕
Position lamps	LED	⊕	⊕
Rear combination lamps	LED	⊕	⊕
Front door windows	Green glass	⊕	-
	Green glass + UV CUT	-	⊕

GRADE	GL	GLX
TRANSMISSION	5MT/4AT	5MT/4AT

VISIBILITY (CONTINUED)

Rear door windows / Rear quarter windows / Tailgate windows	Green glass	⊕	-
	Dark grey glass	-	⊕
Front wiper	2 speeds (low, high) + intermittent + washer	⊕	-
	2 speeds (low, high) + variable intermittent + washer	-	⊕
Rear wiper	1 speed + washer	⊕	-
	1 speed + intermittent + washer	-	⊕
Rear window demister		⊕	⊕
Outside door mirrors	Electrically adjustable	⊕	⊕
	Electrically fold	⊕	-
	Electrical fold (keyless synchronised)	-	⊕
	With built-in turn signal lamps	⊕	⊕
Day / night rearview mirror	Manual dimming	⊕	-
	Automatic dimming	-	⊕

STEERING AND INSTRUMENT PANEL

3-spoke steering wheel	Leather covered	⊕	⊕
	Tilt-adjustable steering wheel	⊕	⊕
	Telescopic-adjustable steering wheel	-	⊕
	With audio controls	⊕	⊕
	With cruise control	⊕	⊕
	With hands-free phone control	⊕	⊕
Electric power steering		⊕	⊕
Tachometer		⊕	⊕
Information display	Segment display	⊕	-
	4.2-inch colour LCD display	-	⊕
	Clock	⊕	⊕
Light-off reminder	Alarm	⊕	⊕
Key reminder	Alarm	⊕	-
Door ajar reminder	Lamp	⊕	⊕
Driver's seatbelt reminder	Lamp & alarm	⊕	⊕

MAJOR EQUIPMENT (CONTINUED)

GRADE	GL	GLX
TRANSMISSION	5MT/4AT	5MT/4AT

STEERING AND INSTRUMENT PANEL (CONTINUED)

Passenger's seatbelt reminder	Lamp & alarm	⊗	⊗
Rear seatbelt reminder	Lamp & alarm	⊗	⊗
Low fuel warning	Lamp	⊗	⊗

DRIVING AMENITIES

Electric windows	Front	⊗	⊗
	Rear	⊗	⊗
Central door locking		⊗	⊗
Keyless entry with push-button start		-	⊗
Air conditioner	Automatic	⊗	⊗
Heater		⊗	⊗
Rear A/C Ventilation		⊗	⊗
Pollen filter		⊗	⊗
Audio	Shark fin antenna (mounted at rear of roof)	⊗	⊗
	Speaker x 4	⊗	⊗
	Tweeter x 1	-	⊗
	7-inch display audio + Bluetooth®* + rearview camera	⊗	-
	9-inch display audio + Bluetooth®* + 360° view camera	-	⊗
Cruise control		⊗	⊗

INTERIOR

Cabin lights	Front map light	⊗	⊗
	Central cabin light (3-position)	⊗	⊗
Ambient lighting	Glove box light	-	⊗
	Footwell light (both front seats)	-	⊗
	Courtesy lamp	-	⊗

GRADE	GL	GLX
TRANSMISSION	5MT/4AT	5MT/4AT

INTERIOR (CONTINUED)

Sun visors	Driver's side	⊗	⊗
	- with ticket holder	-	⊗
	- with vanity mirror	-	⊗
	- with illumination function	-	⊗
Passenger's side		⊗	⊗
	- with ticket holder	-	⊗
	- with vanity mirror	⊗	⊗
	- with illumination function	-	⊗
Assist grips	Passenger's side	⊗	⊗
	Rear x 2	⊗	⊗
Cup holders	Front x 2	⊗	⊗
Bottle holders	Front x 2, Rear x 2	⊗	⊗
Centre console box with armrest		⊗	⊗
Head-up display		-	⊗
Shift knob	with plating	⊗ (MT)	⊗ (MT)
	with satin plating	⊗ (AT)	⊗ (AT)
USB socket	Front	⊗	⊗
12V accessory socket	Front	⊗	⊗
Wireless charger		-	⊗
USB charger	Rear x 2	⊗	⊗
Foot rest	Driver's side	⊗	⊗
Remote fuel lid opener		⊗	⊗
Front and rear door trim	Fabric	⊗	-
	Synthetic leather	-	⊗
Inside door handles	Black	⊗	-
	Chrome	-	⊗

MAJOR EQUIPMENT (CONTINUED)

GRADE	GL	GLX
TRANSMISSION	5MT/4AT	5MT/4AT

SEATS

Front seats	Seat height adjuster (driver's side)	-	⚙
	Head restraints (separate type)	⚙	⚙
	Seatback pocket (passenger's side)	⚙	⚙
Rear seats	60:40-split single-fold	⚙	⚙
	Head restraint x 3 (separate type)	⚙	⚙
Seat upholstery material	Fabric	⚙	⚙

LUGGAGE AREA

Luggage shelf	⚙	⚙
Luggage area light	⚙	⚙

SAFETY, SECURITY, AND ENVIRONMENTAL COMPATIBILITY

SRS front dual airbags		⚙	⚙
SRS side airbags		-	⚙
SRS curtain airbags		-	⚙
Seatbelts	Front: 3-point ELR seatbelts with pretensioner and force limiter	⚙	⚙
ISOFIX lower anchorage	x 2	⚙	⚙
ISOFIX top tether anchorage	x 2	⚙	⚙
Childproof rear door locks		⚙	⚙
Side impact door beams		⚙	⚙
ABS with EBD function		⚙	⚙
ESP ^{®**}		⚙	⚙
Hill hold control		⚙	⚙
Brake assist function		⚙	⚙
Parking sensors	Rear	⚙	⚙

GRADE	GL	GLX
TRANSMISSION	5MT/4AT	5MT/4AT

SAFETY, SECURITY, AND ENVIRONMENTAL COMPATIBILITY (CONTINUED)

LED-DRL (Daytime Running Lights)	⚙	⚙
High-mount stop lamp	⚙	⚙
Immobilizer	⚙	⚙
Security alarm	⚙	⚙
Pedal release system	⚙	⚙

⚙: Standard - : Not available

* Bluetooth is a registered trademark of Bluetooth SIG, Inc.

** ESP is a registered trademark of Mercedes-Benz Group AG.

The ESP is designed to help keep the Fronx under control. However, its effectiveness depends on driving conditions and the state of the road surface. If the tyres exceed their grip limit and the wheels start to spin or skid, it may not be fully effective.

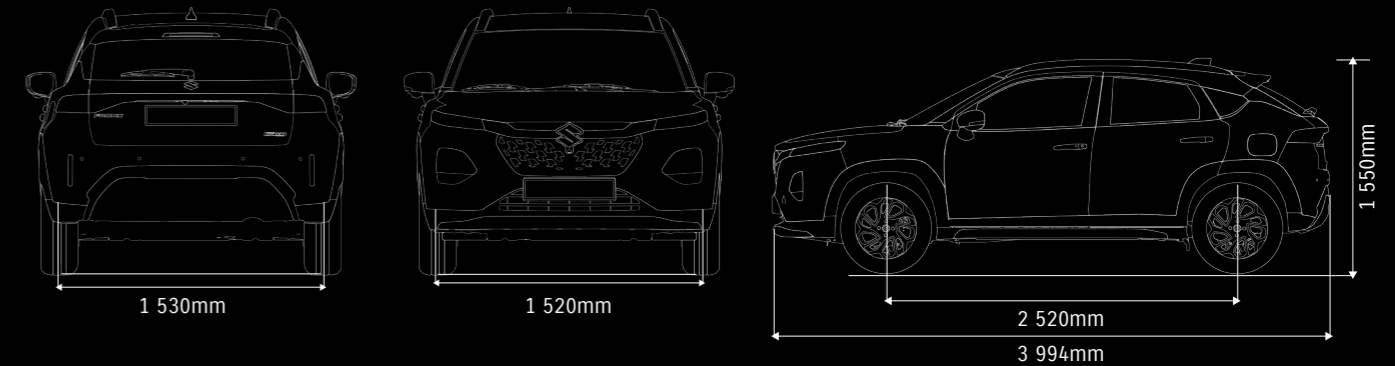



FRONX
SHAPE YOUR New

FRONX

Accessories

Elevate your driving experience to the next level with premium exterior accessories that accentuate the SUV's sporty appearance.

These accessories are designed to give your Fronx undeniable appeal.

EXTERIOR

- 1 | **Front Underbody Spoiler**
Part No. 990J0M74T07-100
■ Grey + Red
- 2 | **Rear Underbody Spoiler**
Part No. 990J0M74T07-110
■ Grey + Red
- 3 | **Side Underbody Spoiler**
Part No. 990J0M74T07-120
■ Grey
- 4 | **ORVM Cover - Red Dash Finish**
Part No. 990J0M74TPJ-030
■ Red Dash Finish
- 5 | **ORVM Garnish**
Part No. 990J0M55T13-080
- 6 | **Door Visor**
Part No. 990J0M55TQ0-010

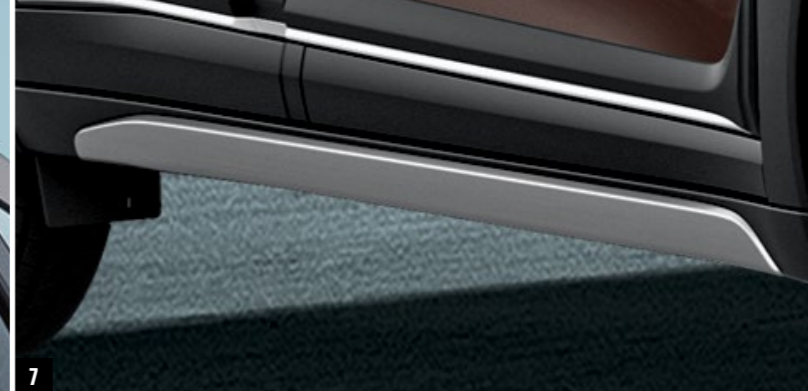
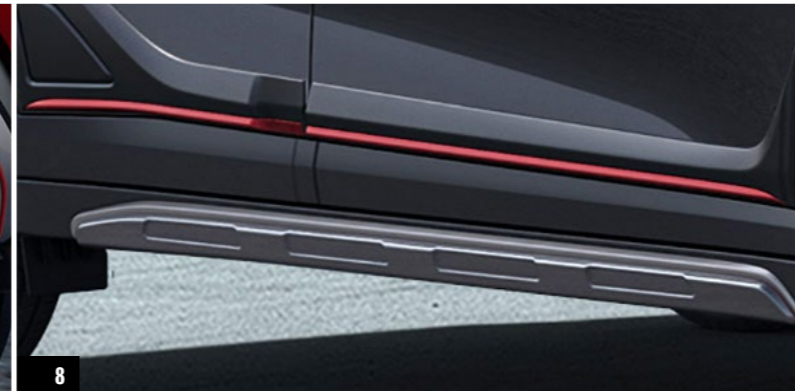

- 7 | **Body Side Moulding - Garnish Insert**
Part No. 990J0M74T01-010
- 8 | **Body Side Moulding**
Part No. 990J0M74T01-020
■ Red Insert
- 9 | **Machined Finish Alloy Wheel (4 Units)**
Part No. 43210M74T60-QC8
- 10 | **Mud Flap Rigid (4 Piece Set)**
Part No. 72201M74T00
- 11 | **Premium Body Cover**
Part No. 990J0M74T02-040
- 12 | **Valve Cap Set (5 Piece)**
Part No. 990J0M999W0-200

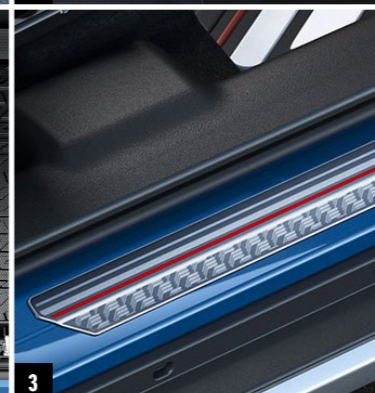

GRAND INTERIOR

Feel right at home inside the stylish interior with premium accessories that add a touch of class and comfort to every drive.

- 1 | Interior Styling Kit**
Part No. 990J0M74TPJ-010
Contains the
A - AC louver,
B - Inside door handle garnish
C - Under audio garnish.
- 2 | Luggage Mat Tray**
Part No. 990J0M74TA3-010
- 3 | Side Sill Scuff**
Part No. 990J0M74TM8-010
- 4 | Deluxe Carpet Mat**
Part No. 75901M74T10
- 5 | Floor Mat - Tray**
Part No. 75901M74TE0



EXPRESS YOURSELF

The Suzuki Fronx comes in a choice of your favourite stylish shades.

SINGLE TONE



Splendid Silver Pearl Metallic



Lucent Orange Pearl Metallic



Celestial Blue Pearl Metallic



Arctic White Pearl



Grandeur Grey Pearl Metallic



Bluish Black Pearl

TWO-TONE



Splendid Silver Pearl Metallic
x Bluish Black Pearl



Lucent Orange Pearl Metallic
x Bluish Black Pearl



Opulent Red Pearl Metallic
x Bluish Black Pearl



SUZUKI

COMPLETE

Suzuki understands that purchasing a new vehicle is a substantial investment. Our unwavering commitment to customer satisfaction is represented in our 'Suzuki Complete' package, which includes every aspect of after-sales support, with warranty, service plan, and roadside assistance standard.

Warranty

All Suzuki models are covered by a comprehensive promotional warranty against any defects for a period of 5 year/200 000km. This is supported by a six-year body corrosion warranty subject to terms and conditions.

Service Plan

The Fronx benefits from a 4 year/60 000km service plan. This plan includes the replacement of oil, the oil filter, fuel filter, brake fluid, air filter and accessory belts, but excludes tyres, brakes and other wear-and-tear items.

Service Intervals

15 000 km or one year, whichever comes first.

Roadside Assistance

Every new Fronx comes with a five-year roadside assistance plan. Some of the benefits offered by this comprehensive package include: battery and locksmith call-out services, mechanical and electrical, breakdown towing (accident towing is optional), emergency medical rescue, vehicle repatriation and a stand-by-you roadside security armed-response service.

All care is taken to ensure the accuracy of this brochure at the time of print approval. Specifications, features, prices and model availability may vary from those specified and may change without notice. Always consult your authorised Suzuki Dealer or refer to www.SuzukiAuto.co.za for the latest details on all models. SUZUKI AUTO South Africa (PTY) Ltd will not be held liable for any loss as a result of reliance on the content of this brochure, whether in negligence or otherwise. Vehicles are shown for illustrative purposes only and may not depict exact specifications. Published August 2023.

Part number 9900L-74T00-BRO



SUZUKI AUTO SOUTH AFRICA (PTY) LTD | Tel: 0861 511 111
No.52 Saturn Crescent, Linbro Business Park, Frankenwald, Marlboro, Sandton
www.SuzukiAuto.co.za

